



S1000RR 2019

FITTING INSTRUCTIONS TO BE FITTED BY A QUALIFIED TECHNICIAN



THIS SHEET INCLUDES FITTING INSTRUCTIONS FOR THE FOLLOWING PARTS:

Secondary Alternator Cover Part No. EC-S1000RR-2019-1-GBR / Secondary Clutch Cover Part No. EC-S1000RR-2019-2-GBR / Secondary Pulse Cover Part No. EC-S1000RR-2019-3-GBR / Secondary Water Pump Cover Part No. EC-S1000RR-2019-5-GBR / Bullet Frame Sliders FS-S1000RR-2019-R



SECONDARY ALTERNATOR COVER PART NO. EC-S1000RR-2019-1-GBR

- 1 Remove 4 existing stretch bolts from the stock Alternator cover, shown as position Bolt 1, 2, 3 & 4.
- 2 Place the Secondary Alternator Cover over the stock cover.
- 3 Assemble 4 replacement stainless steel M6X40A2 TORX bolts loosely in the correct position as shown.
- 4 Tighten bolts to a Torque of 10Nm. DO NOT OVERTIGHTEN.

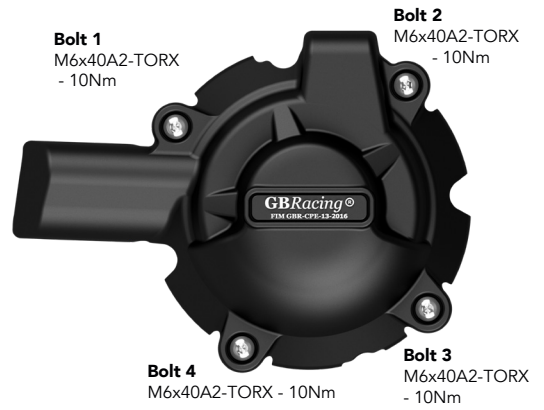
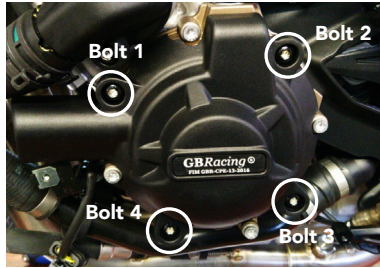
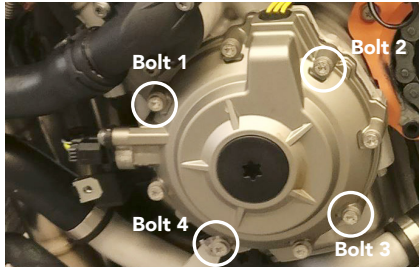

SECONDARY CLUTCH COVER PART NO. EC-S1000RR-2019-2-GBR

- 1 Remove Upper fairing.
- 2 Remove 4 existing bolts from the stock clutch cover, shown as position Bolt 1, 2, 3 & 4.
- 3 Place the Secondary Clutch Cover over the stock cover.
- 4 Assemble 4 replacement M6X40A2 TORX bolts, loosely in the correct position as shown.
- 5 Tighten bolts to a Torque of 10Nm. DO NOT OVERTIGHTEN.
- 6 Re-Fit Upper Fairing.

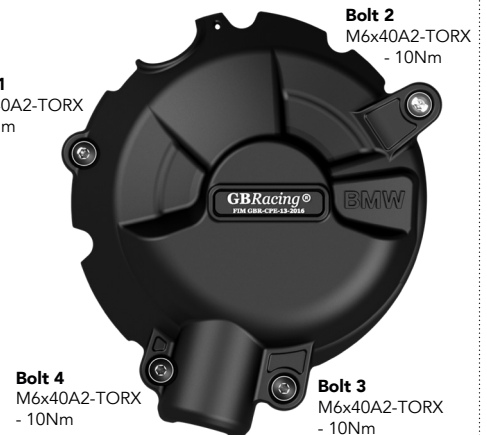
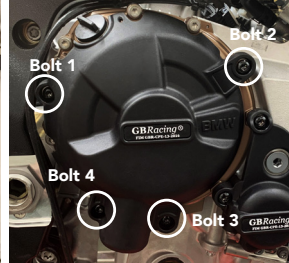
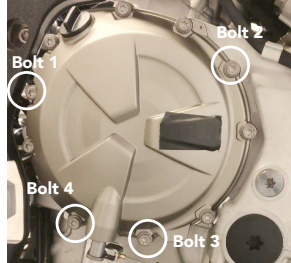

SECONDARY PULSE COVER PART NO. EC-S1000RR-2019-3-GBR

- 1 Remove 3 existing bolts from the stock pulse cover, shown as position Bolts 1, 2 & 3.
- 2 Place the Secondary Pulse Cover over the stock cover.
- 3 Assemble 2 replacement M6X40A2 TORX bolts, loosely in the correct position as shown.
- 4 Bolt 2 M6X30A2 TORX will secure to the fixing bracket as shown in Fig 1.
- 5 Tighten bolts to a Torque of 10Nm. DO NOT OVERTIGHTEN.

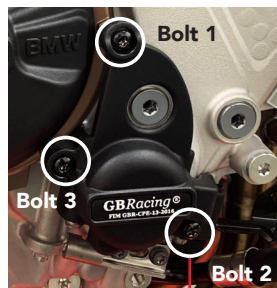
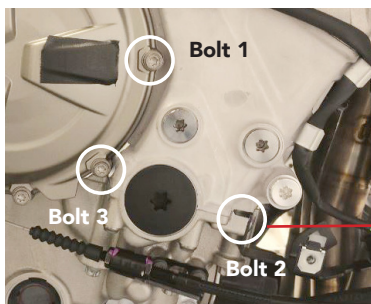
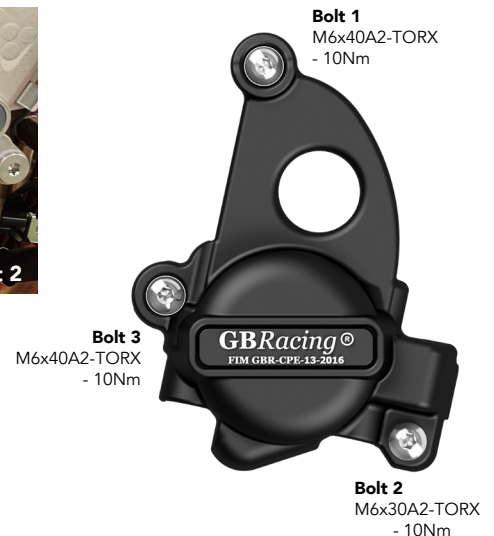

Fig 1.

Fixing Bracket (EC-S1000RR-2019-3-FB-GBR)
for Bolt 2



M6P1-1 (Bush)
M6X30A2 - TORX - 10Nm





S1000RR 2019

FITTING INSTRUCTIONS TO BE FITTED BY A QUALIFIED TECHNICIAN



SECONDARY WATER PUMP COVER PART NO. EC-S1000RR-2019-5-GBR

- 1 Fitting requires a COLD engine.
- 2 Decompress the system before loosening existing stock bolts.
- 3 Have all 3 Replacement Bolts to hand before removing existing stock bolts.
- 4 Loosen bottom fairing bolt to enable access to the Water Pump.
- 5 Remove 3 existing bolts from the stock water pump cover shown as bolt positions 1, 2 & 3
- 6 Place the Secondary Water Pump Cover over the stock cover.
- 7 Assemble 3 replacement bolts, loosely in the correct position as shown.
- 8 Tighten bolts to a Torque of 10Nm.
DO NOT OVERTIGHTEN.
- 9 Tighten bottom fairing bolt.
- 10 Check coolant level & top up if necessary before starting engine.

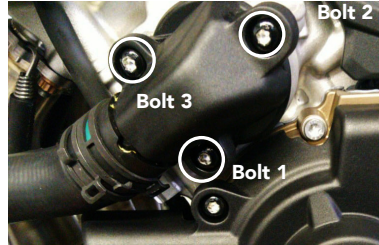

Bolt 1
M6X30A2-TORX
- 10Nm

Bolt 2
M6X30A2-TORX
- 10Nm

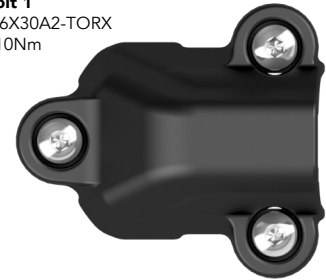

Bolt 3
M6X30A2-TORX
- 10Nm

Engine Cover Set: EC-S1000RR-2019-SET-GBR: EC-S1000RR-2019-1-GBR, EC-S1000RR-2019-2-GBR, EC-S1000RR-2019-3-GBR, EC-S1000RR-2019-3-FB-GBR, EC-S1000RR-2019-5-GBR

Bullet Frame Slider Set: Part No. FS-S1000RR-2019-R:

BULLET FRAME SLIDER - LEFT HAND SIDE - RACE PART NO. FS-S1000RR-2019-LHS-R

- 1 Remove fairing.
- 2 Remove upper engine mounting bolt.
- 3 Assemble bolt through the aluminium bush into correct position.
- 4 Drill fairing.
- 5 Tighten to 40Nm torque.
- 6 Replace fairing.
- 7 Slide bullet moulding onto aluminium bush.
- 8 Screw M6 bolt into front of bullet moulding hand tight.



CPM-3

CPB-10-20

M10x55



BULLET FRAME SLIDER - RIGHT HAND SIDE - RACE PART NO. FS-S1000RR-2019-RHS-R

- 1 Remove fairing.
- 2 Remove upper engine mounting bolt.
- 3 Assemble bolt through the aluminium bush into correct position.
- 4 Drill fairing.
- 5 Tighten to 40Nm torque.
- 6 Replace fairing.
- 7 Slide bullet moulding onto aluminium bush.
- 8 Screw M6 bolt into front of bullet moulding hand tight.



CPM-3

CPB-10-15

M10x55

